

LMC

Straight joint, open, single sealed

Installation instructions

1/3

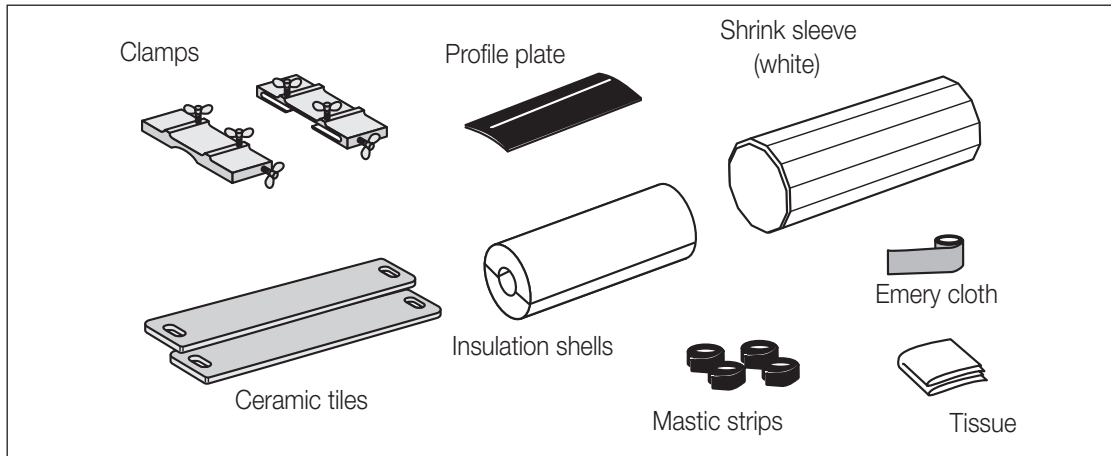

Important:

Never apply heat to creases, if any, since the sleeve material will be discoloured and the surface will crack.

Never apply heat underneath the sleeve at the ends, since this may damage the sleeve permanently.

Pockets of air under the sleeve can be removed by bending a piece of welding wire into U-shape and pushing it underneath the sleeve while it is still warm.

Use burner head $\varnothing 51$ mm for sleeves up to $\varnothing 200$ mm. For larger sleeves use burner head $\varnothing 63$ mm.

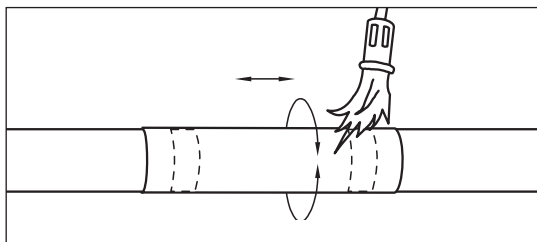

1. Apply heat to "old" shrink sleeve.

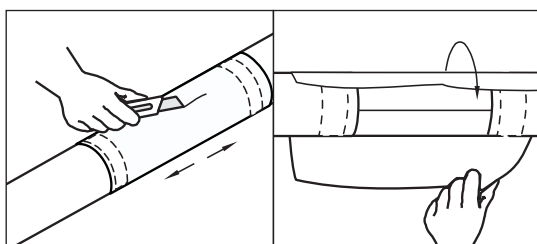

2. Use a sharp knife to cut lengthwise through the old shrink sleeve. Remove shrink sleeve.

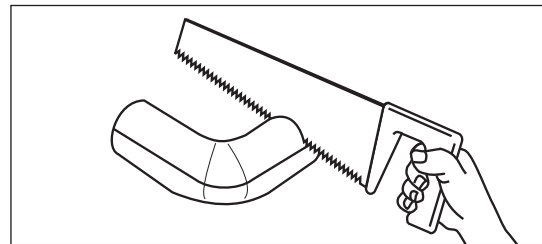

3. Shorten the insulation shells to make them fit tightly between the jacket pipes.

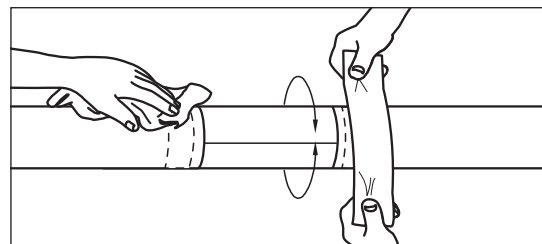

4. Clean the jacket with tissue. Activate the jacket pipes with EMERY CLOTH at least 80 mm from both jacket ends. Use EMERY CLOTH to remove sharp edges or burrs on the jacket pipes.

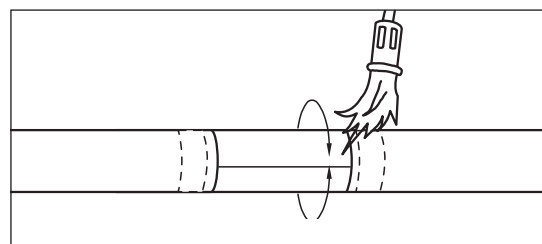

5. Activate the jacket pipes with gas burner at least 80 mm from both jacket ends, until the surface has a matt, silky look.

LMC

Straight joint, open, single sealed

Installation instructions

2/3

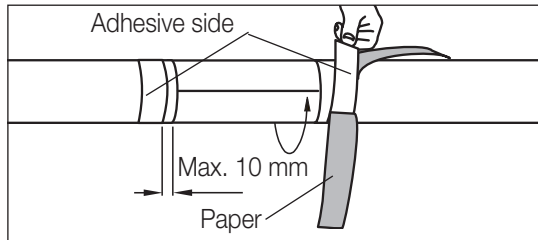

6. Remove the paper from the adhesive side of the mastic strip. Place the adhesive side face down on the jacket pipe furthest from the insulation shells. The mastic strips are placed max. 10 mm from the end of the jacket pipe.

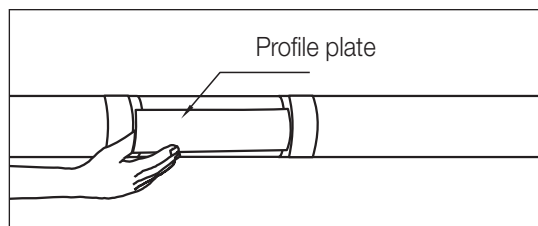

7. Place the profile plate where the ends of the shrink sleeve are to meet. Fasten the profile plate by means of the mastic strips.

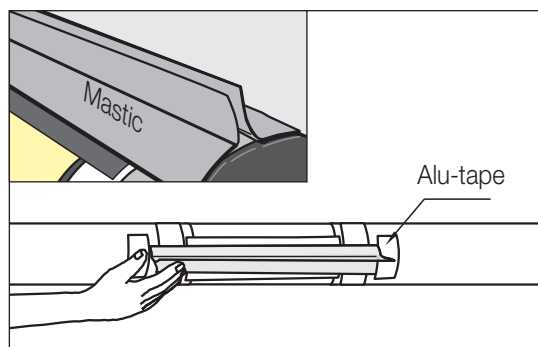

8. Remove the protective paper from the mastic strips and place the strip with the adhesive side facing down and the glue zone facing up on the jacket. Alu-tape can be applied to ease the removal of excess glue.

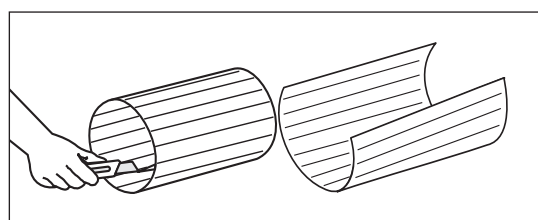

9. Cut lengthwise through the shrink sleeve.

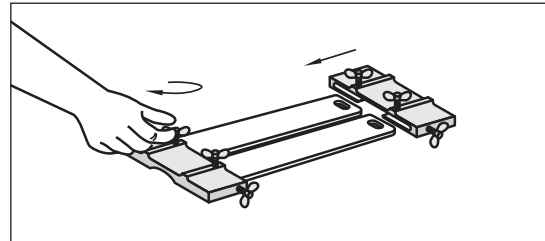

10. Assemble the clamping tool with the glazed side facing downwards.

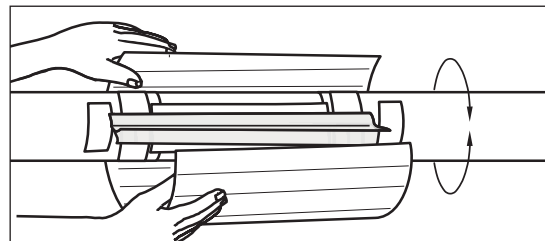

11. Fit the shrink sleeve on the pipe. Make sure that the assembly is centred on the profile plate.

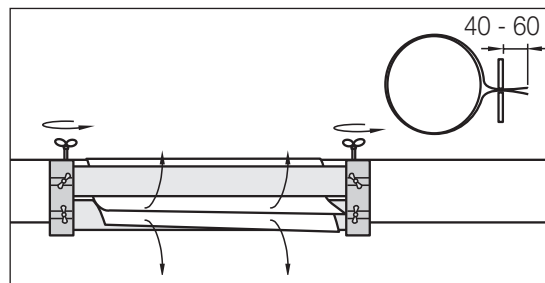

12. Pull the ends of the shrink sleeve 40-60 mm through the clamping tool. Tighten the nuts so that the tiles lock the ends.

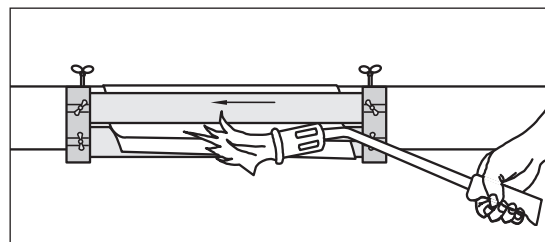

13. Start by shrinking the ends of the shrink sleeve in the clamping tool until the ends stop shrinking.

LMC

Straight joint, open, single sealed

Installation instructions

3/3

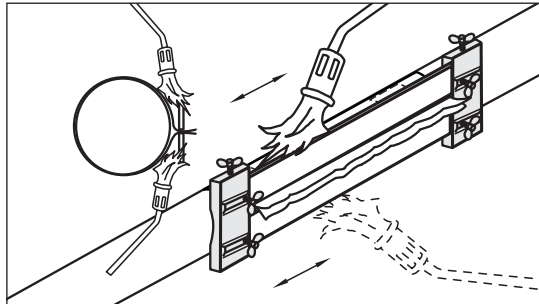

14. Apply heat to the whole clamping tool area.

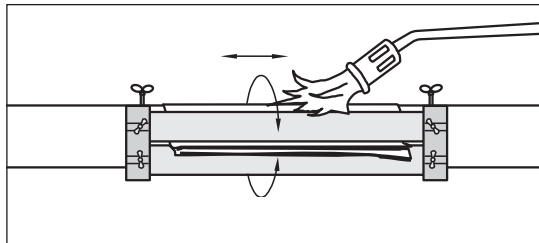

15. Apply heat to the whole shrink sleeve from the middle towards both sides, so that the sealing compound flows out along the edges.

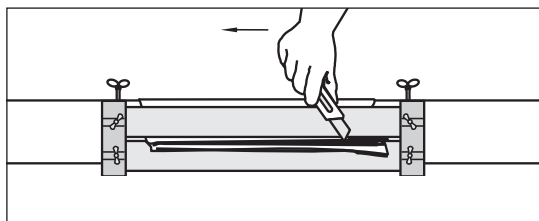
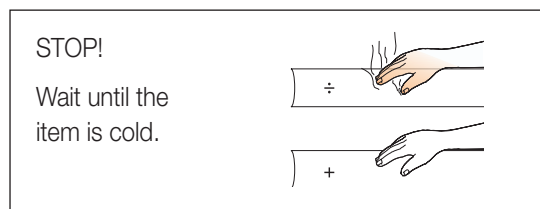

16. Use a very sharp knife to cut along the outer edge of the ceramic tiles.

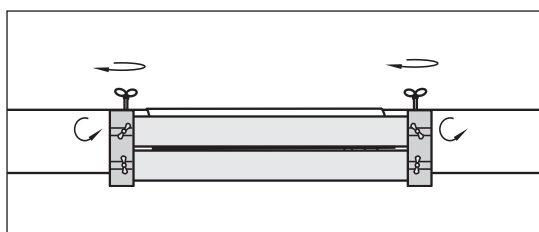

17. Loosen the 4 nuts.

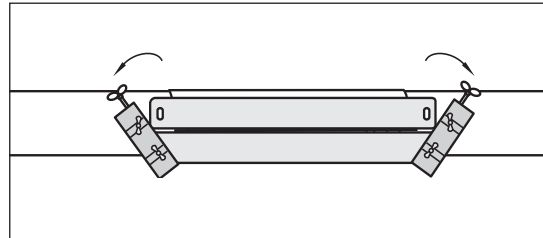

18. Turn the clamps outwards.

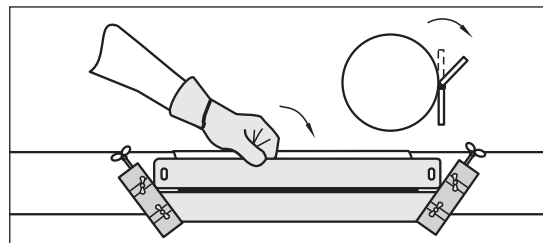

19. Remove tile 1. Important! Always use gloves.

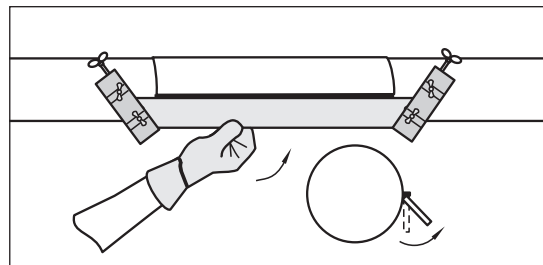

20. Remove tile 2. Important! Always use gloves.

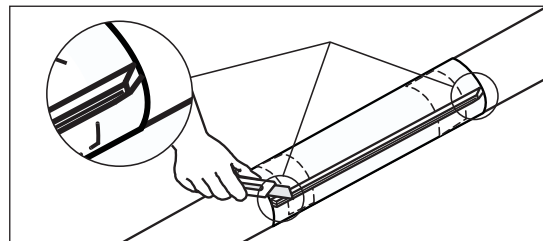

21. Bevel the ends at an angle of 60°. Remove excess glue and alu-tape.

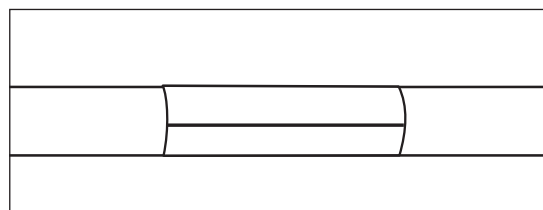

22. The joint is complete.